

# RG-ES106D-P V2 Switch

## Hardware Installation and Reference Guide

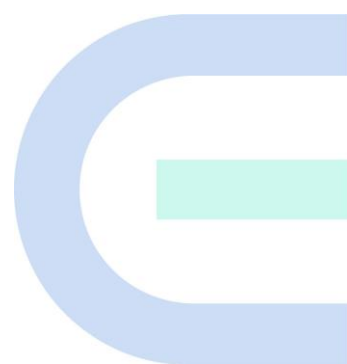

## Copyright

Ruijie Networks©2024

Ruijie Networks reserves all copyrights of this document.

Any reproduction, excerption, backup, modification, transmission, translation or commercial use of this document or any portion of this document, in any form or by any means, without the prior written consent of Ruijie Networks is prohibited.

Trademarks including ,  , are owned by Ruijie Networks.

All other trademarks or registered trademarks mentioned in this document are owned by their respective owners.

## Disclaimer

The products, services or features you purchase are subject to commercial contracts and terms. Some or all of the products, services or features described in this document may not be within the scope of your purchase or use. Unless otherwise agreed in the contract, Ruijie Networks does not make any express or implied statement or guarantee for the content of this document.

Due to product version upgrades or other reasons, the content of this document will be updated from time to time. Ruijie Networks reserves the right to modify the content of the document without any notice or prompt.

This manual is for reference only. Ruijie Networks endeavors to ensure content accuracy and will not shoulder any responsibility for losses and damages caused due to content omissions, inaccuracies or errors.

# Preface

## Intended Audience

This document is intended for:

- Network engineers
- Technical support and servicing engineers
- Network administrators

## Technical Support

- Official website of Ruijie Reyee: <https://www.ruijienetworks.com/products/reyee>
- Technical Support Website: <https://ruijienetworks.com/support>
- Case Portal: <https://www.ruijienetworks.com/support/caseportal>
- Community: <https://community.ruijienetworks.com>
- Technical Support Email: [service\\_rj@ruijienetworks.com](mailto:service_rj@ruijienetworks.com)
- Online Robot/Live Chat: <https://ruijienetworks.com/rita>

## Conventions

### 1. Signs

The symbols used in this document are described as follows:

---

 **Danger**

An alert that calls attention to safety operation instructions that if not understood or followed when operating the device can result in physical injury.

---

 **Warning**

An alert that calls attention to important rules and information that if not understood or followed can result in data loss or equipment damage.

---

 **Caution**

An alert that calls attention to essential information that if not understood or followed can result in function failure or performance degradation.

---

 **Note**

An alert that contains additional or supplementary information that if not understood or followed will not lead to serious consequences.

---

 **Specification**

An alert that contains a description of product or version support.

---

## **2. Note**

This manual provides the device installation steps, hardware troubleshooting, module technical specifications, and specifications and usage guidelines for cables and connectors. It is intended for the users who have some experience in installing and maintaining network hardware. At the same time, it is assumed that the users are already familiar with the related terms and concepts.

# Contents

Preface .....	1
1 Product Overview .....	1
1.1 Package Contents.....	1
1.2 Appearance.....	1
1.2.1 Front Panel.....	2
1.2.2 Rear Panel .....	3
1.3 Technical Specifications .....	3
1.4 Cooling.....	5
2 Preparing for Installation .....	6
2.1 Safety Precautions.....	6
2.1.1 General Safety Precautions.....	6
2.1.2 Handling Safety.....	6
2.1.3 Electric Safety .....	6
2.1.4 Electrostatic Discharge Safety.....	7
2.2 Installation Environment Requirements.....	7
2.2.1 Bearing Requirements .....	7
2.2.2 Ventilation Requirements.....	7
2.2.3 Space Requirements .....	8
2.2.4 Temperature and Humidity Requirements.....	8
2.2.5 Cleanliness Requirements.....	8
2.2.6 Grounding Requirements.....	9
2.2.7 Anti-interference Requirements .....	10
2.2.8 Lightning Protection Requirement .....	10

2.2.9 Installation Site Requirements .....	10
2.3 Tools .....	10
3 Installing the Switch .....	11
3.1 Before You Begin.....	11
3.2 Precautions .....	11
3.3 Mounting the Switch .....	12
3.3.1 Mounting the Switch on a Wall .....	12
3.3.2 Mounting the Switch on a Workbench .....	12
3.4 Grounding the Switch .....	13
3.4.1 Connecting Cables.....	13
3.5 Checking after installation.....	13
4 Verifying Operating Status .....	14
4.1 Powering on the Switch .....	14
4.1.1 Checklist before Power-on.....	14
4.1.2 Checklist after Power-on.....	14
5 Appendix.....	15
5.1 Connectors and Media.....	15
5.2 Lightning Protection .....	16
5.2.1 Installing AC Power Arrester (lightning protection cable row) .....	16
5.2.2 Installing the Ethernet Port Arrester.....	17

# 1 Product Overview

RG-ES106D-P V2 is a 100M Ethernet PoE switch, providing six 10/100 Mbps self-adaptive Ethernet RJ45 ports with line-rate forwarding performance. As four ports are PoE-capable and are backward compliant with IEEE802.3at standard, the RG-ES106D-P V2 can serve as a PoE device. The switch can automatically identify the powered devices compliant with IEEE802.3at/af standard and supply power for such devices through Ethernet cables. You can switch the working mode by toggling the DIP switch on the front panel for flow control and port isolation.

The RG-ES106D-P V2 switch features easy operation and plug-and-play without any configuration. It can work with more video monitoring devices and access points without being limited by the electric wiring. The switch is an ideal choice for the small- and medium-sized Ethernet.

## 1.1 Package Contents

Table 1-1 Package Contents

Item	Quantity
RG-ES106D-P V2 Switch	1
Power Adapter (1.2 m/3.94 ft)	1
KA3 x 25 mm Screw	2
Expansion Anchor	2
User Manual	1

---

**Note**

The package contents are subject to the purchase contract. The actual delivery prevails. Please check the items carefully against the package contents or purchase contract. If you have any questions or there are any errors, please contact your distributor.

---

## 1.2 Appearance

The RG-ES106D-P V2 switch provides six 10/100Base-TX self-adaptive Ethernet ports, a DIP switch, a system LED and other LEDs on the front panel and a DC input plug as well as a grounding stud on the rear panel.

**Figure 1-2 Appearance of a RG-ES106D-P V2 Switch**

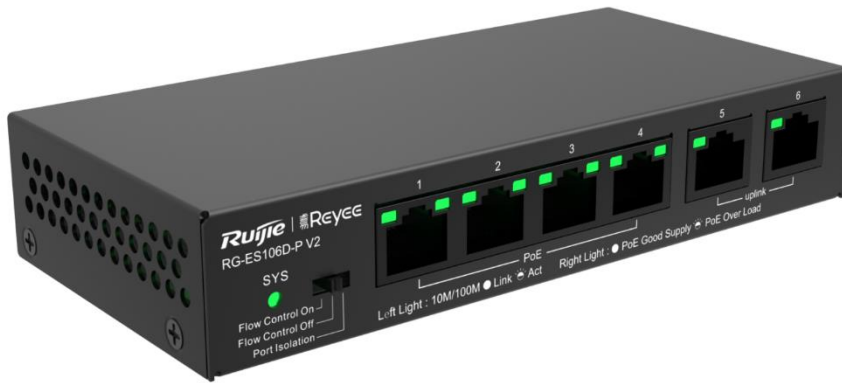

### 1.2.1 Front Panel

**Figure 1-3 Front Panel of a RG-ES106D-P V2 Switch**

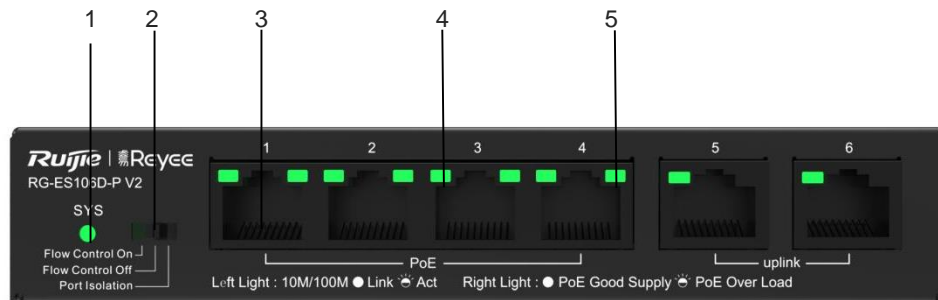

**Table 1-2 Front Panel Specifications**

No.	Item	Description
1	System Status LED	Off: The device is not powered on. Solid on: The device is powered on.
2	DIP Switch	The DIP switch is used to switch the working mode. Standard mode: Flow control is enabled and all ports can communicate with each other. Flow Control Off mode: Flow control is disabled and all ports can communicate with each other. . VLAN mode: Ports 1 to 4 cannot communicate with each other but they can communicate with ports 5 and 6.
3	10/100Base-T Self-adaptive Ethernet Ports	Six 10/100M self-adaptive Ethernet RJ45 ports (Auto MDI/MDIX). Ports 1-4 are PoE-capable.
4	10/100Base-T Link/Act LED (1-6)	Solid green: The port has made a successful 10/100 Mbps link Blinking green: The port is sending and receiving traffic at 10/100



No.	Item	Description
		Mbps. Off: The port is not connected.
5	PoE LED	Solid green: PoE is enabled. Blinking green: PoE overload occurs. Off: PoE is disabled.

### 1.2.2 Rear Panel

Figure 1-4 Rear Panel of a RG-ES106D-P V2 Switch

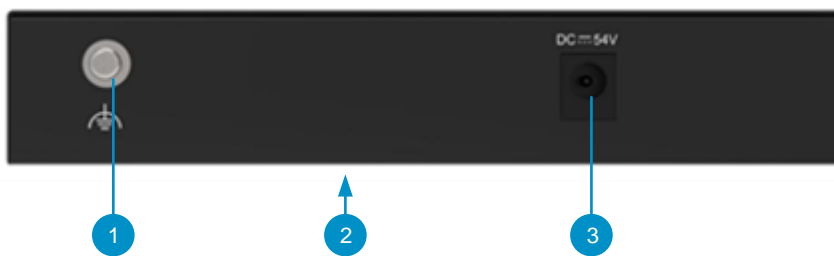

Table 1-3 Rear Panel Specifications

No.	Item	Description
1	Grounding Stud	Connect the grounding stud to the protection ground with the grounding cable to provide grounding protection.
2	Nameplate	Nameplate on the bottom of the device
3	DC Input Plug	Connect the DC power adapter to the DC input plug to power on the switch.

### 1.3 Technical Specifications

Table 1-4 Technical Specifications of a RG-ES106D-P V2 Switch

<b>Model</b>	RG-ES106D-P V2
<b>Ports</b>	Six 10/100 Mbps self-adaptive Ethernet ports (Auto MDI/MDIX). Ports 1-4 are PoE-capable.
<b>Power Supply</b>	AC input: Rated voltage range: 100 V AC to 240 V AC Maximum voltage range: 90 V AC to 264 V AC Frequency: 50 Hz/60 Hz

	<p>Rated current: 1.5 A</p> <p>DC output:</p> <p>Rated voltage: 54 V DC</p> <p>Rated current: 1.11 A</p> <p>Dimensions of a DC connector: outer diameter: 5.5 mm (0.22 in.), inner diameter: 2.1 mm (0.08 in.), depth: 10 mm (0.39 in.)</p>
<b>EEE</b>	Disabled by default
<b>PoE</b>	<p>Compliant with IEEE 802.af/at</p> <p>Ports 1-4 are PoE/PoE+ capable.</p> <p>Maximum PoE+ output power per port: 30 W</p> <p>Maximum PoE/PoE+ output power per device: 54 W</p>
<b>PoE Power Cable Pairs</b>	Mode A (1-2, 3-6 pairs)
<b>Maximum Power Consumption</b>	60.6 W
<b>Working Mode</b>	<p>Standard mode: Flow control is enabled and all ports can communicate with each other.</p> <p>Flow Control Off mode: Flow control is disabled and all ports can communicate with each other.</p> <p>VLAN mode: Ports 1 to 4 cannot communicate with each other but they can communicate with ports 5 and 6.</p>
<b>Operating Temperature</b>	0°C to 45°C (32°F to 113 °F)
<b>Storage Temperature</b>	-40°C to 70°C (-40°F to 158°F)
<b>Operating Humidity</b>	10% to 90% RH (non-condensing)
<b>Storage Humidity</b>	5% to 95% RH (non-condensing)
<b>Lightning Protection (Port Surge)</b>	4 KV
<b>Fan</b>	Fanless design
<b>Certification</b>	CE
<b>Ground Leakage Current</b>	≤ 3.5 mA
<b>Dimensions (W x D x H)</b>	140 mm x 67 mm x 26 mm (5.51 in. x 2.64 in. x 1.02 in.)
<b>Weight</b>	0.75 kg (1.65 lbs, with packaging materials)

 **Warning**

Operation of this equipment in a residential environment could cause radio interference.

## 1.4 Cooling

The RG-ES106D-P V2 switch adopts natural heat dissipation without fans. Please maintain a minimum clearance of 100 mm (3.94 in.) around the device to ensure normal operation. Dust the device every three months to avoid blocking the ventilation openings.

# 2 Preparing for Installation

## 2.1 Safety Precautions

---

### Note

To avoid body injury and device damage, please carefully read the safety precautions before you install the RG-ES106D-P V2 switch.

The following safety precautions may not cover all possible dangers.

---

### 2.1.1 General Safety Precautions

- Do not place the switch in a wet area, and keep the switch away from liquid. Keep the chassis clean and dust-free.
- Keep the device away from heat sources.
- Do not place the device, tools and accessories in walking areas.
- Do not wear loose clothes, ornaments or any other things that may be hooked by the chassis during the installation and maintenance.

### 2.1.2 Handling Safety

- Avoid handling the device frequently after the device is installed.
- Turn off all power supplies and unplug all power cords and cables before the installation or the dismantling.

### 2.1.3 Electric Safety

---

#### Warning

Any nonstandard and inaccurate electrical operation can cause accidents such as fires or electrical attacks, thus causing severe, or even fatal damages to human bodies and the devices.

Direct or indirect touch through a wet object on high-voltage and mains supply can bring a fatal danger.

---

- Observe local regulations and specifications when electric operations are performed. Relevant operators must be qualified.
- Carefully check any potential danger in the working area, such as ungrounded power supply, unreliable grounding of the power supply, and damp/wet ground.
- Find out the location of the emergency power supply switch in the room before installation. First cut off the power supply in the case of an accident.
- Be sure to make a careful check before you shut down the power supply.
- Select a correct leakage protector (also referred to as “leakage current switch” or “leakage current breaker”) for the power supply system. When there is a risk of leakage and electric shock, the power supply is automatically disconnected. A correct leakage protector should meet the following requirements:

- The rated leakage action current of each leakage protector is greater than twice of the theoretical maximum leakage current of all the power supplies in the system. For example, if a system is equipped with 16 identical power supplies, the leakage current of each power supply is equal to or less than 3.5 mA, and the leakage current of the system totals 56 mA. A leakage protector with 30 mA rated action current supports less than five power supplies (that is, Action current of the leakage protector/2/Maximum leakage current of each power supply =  $30/2/3.5 \approx 4.28$ ). In other words, the leakage protector with 30 mA rated action current supports no more than four power supplies. In this case, the 16 power supplies in the system require at least four leakage protectors with 30 mA rated action current and each leakage protector supports four power supplies. If power supplies in a system differ in models, the rated leakage action current of each leakage protector divided by two is greater than the sum of maximum leakage currents of all the power supplies.
- The rated leakage non-action current of a leakage protector shall be 50% of the leakage action current. Take a leakage protector with 30 mA rated leakage action current as an example. The rated leakage non-action current shall be 15 mA. When the leakage current is below 15 mA, the protector shall not act.

---

 **Caution**

To guarantee personal safety, the rated leakage action current of each leakage protector in the system must be equal to or less than 30 mA (human body safety current is 30 mA). When twice of the total leakage current of the system is greater than 30 mA, the system must be equipped with two or more leakage protectors.

For the leakage current value, see [Section 1.3 Technical Specifications](#).

---

## 2.1.4 Electrostatic Discharge Safety

- Properly ground the device and floor.
- Keep the indoor installation environment clean and free of dust.
- Maintain appropriate humidity conditions.
- Before installing the various pluggable modules, please wear an anti-static wrist strap and make sure that it is well grounded.

## 2.2 Installation Environment Requirements

Install the RG-ES106D-P V2 switch indoors to ensure its normal operation and prolonged service life. The installation site must meet the following requirements.

### 2.2.1 Bearing Requirements

Evaluate the weight of the switch and its accessories (for example, the power supply modules), and ensure that the ground of the installation site meets the requirements

### 2.2.2 Ventilation Requirements

Maintain a proper clearance around the device for air circulation and normal heat dissipation. After various cables are connected, bundle the cables or place them in the cable management bracket to avoid blocking air inlets

### 2.2.3 Space Requirements

Please do not install the switch against the wall. Instead, please maintain a minimum clearance of 0.4 m (15.75 in.) around the switch for heat dissipation and device maintenance.

### 2.2.4 Temperature and Humidity Requirements

To ensure the normal operation and a prolonged service life of the RG-ES106D-P V2 switch, maintain an appropriate temperature and humidity in the equipment room. The equipment room with too high or too low temperature and humidity for a long period of time may damage the equipment.

- In an environment with high relative humidity, the insulating material may have bad insulation or even leak electricity. And sometimes the materials may suffer from mechanical performance change and metallic parts may get rusted.
- In an environment with low relative humidity, the insulating strip may dry and shrink, and static electricity may occur easily and endanger the circuit on the device.
- In a dry environment, static electricity is prone to occur and damage the internal circuits of the device.
- In an environment with high temperature, the equipment is subjected to even greater harm, as its performance may degrade significantly and its service life may be shortened at high temperature for long that expedites the aging process.

---

#### Note

The ambient temperature and humidity of the switch are measured at the point that is 1.5 m (59.06 in.) above the floor and 0.4 m (15.75 in.) before the switch rack when there is no protective plate in front or at the back of the rack.

---

### 2.2.5 Cleanliness Requirements

Dust poses a major threat to the running of the device. The indoor dust falling on the device may be adhered by the static electricity, causing poor contact of the metallic joint. Such electrostatic adherence may occur more easily when the relative humidity is low, not only affecting the service life of the device, but also causing communication faults. The following table shows the requirements for the dust content and granularity in the equipment room.

**Table 2-1 Requirements for Dust**

Dust	Unit	Content
Dust particles (diameter $\geq 0.5 \mu\text{m}$ )	Particles/m <sup>3</sup>	$\leq 3.5 \times 10^6$
Dust particles (diameter $\geq 5 \mu\text{m}$ )	Particles/m <sup>3</sup>	$\leq 3.5 \times 10^4$

Apart from dust, the salt, acid and sulfide in the air in the equipment room must also meet strict requirements. These harmful substances will accelerate metal corrosion and component aging. Therefore, the equipment room should be properly protected against the intrusion of harmful gases, such as sulfur dioxide, hydrogen sulfide, nitrogen dioxide, and chlorine gas. The following table lists limit values for harmful gases.

**Table 2-2 Requirements for Gases**

Gas	Average (mg/m <sup>3</sup> )	Maximum (mg/m <sup>3</sup> )
Sulfur dioxide (SO <sub>2</sub> )	0.3	1.0
Hydrogen sulfide (H <sub>2</sub> S)	0.1	0.5
Nitrogen dioxide (NO <sub>2</sub> )	0.5	1.0
Chlorine gas (Cl <sub>2</sub> )	0.1	0.3

 **Note**

The **Average** refers to the average value of harmful gas in one week. The **Maximum** value is the upper limit of the harmful gas in one week, and maximum value can last for up to 30 minutes every day.

## 2.2.6 Grounding Requirements

A proper grounding system is the basis for stable and reliable running and is indispensable for preventing lightning strikes and interference. Carefully check the grounding conditions at the installation site according to the grounding specifications, and complete grounding properly based on the actual situation.

- **Safety Grounding**

Ensure that the cabinet and power distribution device are securely grounded when the device uses the AC power supply. Otherwise, electric shock may occur when the insulation resistance between the power supply inside the device and the chassis becomes small.

 **Caution**

Please adopt protection grounding connections in buildings so that the device can be connected to the protection ground.

Check whether the AC socket is reliably connected to the protection ground of the building. If not, a protection ground wire should be used to connect the protection ground lug of the AC socket to the protection ground of the building.

The cross-sectional area of the protection ground cable should be at least 0.75 mm<sup>2</sup> (18 AWG).

- **Lightning Grounding**

The lightning protection system of facilities is standalone, and is composed of a lightning rod, a lower conductor, and a connector connected to the grounding system. The grounding system is usually used for power reference grounding and safety grounding of the cabinet. Lightning grounding is required only for facilities and is not required for the device

- **EMC Grounding**

Grounding required for electromagnetic compatibility includes shielded grounding, filter grounding, noise and interference suppression, and level reference, which contribute to the overall grounding requirements. The grounding resistance should be smaller than 1 ohm, and the ground terminals of the cabinet should be grounded before the running of the device.

## 2.2.7 Anti-interference Requirements

- Take interference prevention measures for the power supply system.
- Keep the device away from the grounding equipment or lightning and grounding equipment of the power device as much as possible.
- Keep the device far away from high-frequency current devices such as high-power radio transmitting station and radar launcher.
- Take electromagnetic shielding measures when necessary.

## 2.2.8 Lightning Protection Requirement

The device can guard against lightning strikes. As an electric device, it may still be damaged by strong lightning strikes. Take the following lightning protection measures:

- Ensure that the grounding cable of the cabinet is in good contact with the ground.
- Ensure that the neutral point of the AC power socket is in good contact with the ground.
- You are advised to install a power lightning arrester in front of the power input end to enhance the lightning prevention for the power supply.

## 2.2.9 Installation Site Requirements

Regardless of whether the device is installed on a wall or workbench, the following conditions must be met:

- Maintain a proper clearance around the air vents for heat dissipation.
- Place the device on a clean workbench. In hot areas, air-conditioning is recommended.
- The workbench has proper ventilation and heat dissipation.
- The workbench is sturdy enough to support the weight of the device and its accessories.
- The workbench is properly grounded.

## 2.3 Tools

Table 2-3 Tools

<b>Common Tools</b>	Phillips screwdrivers, power cords, Ethernet cables, fastening bolts, diagonal pliers, and binding straps
<b>Special Tools</b>	Antistatic gloves, wire stripper, crimping pliers, crystal connector crimping pliers, and wire cutter
<b>Meters</b>	Multimeter
<b>Relevant Devices</b>	PC, display, keyboard

### Note

The RG-ES106D-P V2 switch is not delivered with a tool kit. The tool kit is customer-supplied.



# 3 Installing the Switch

---

## Caution

Please ensure that you have carefully read Chapter 2 and make sure that the requirements in Chapter 2 are all met.

---

## 3.1 Before You Begin

- The installation location provides sufficient space for heat dissipation.
- The installation location meets the temperature and humidity requirements of the device.
- The power supply and required current are available in the installation site.
- The Ethernet cables have been deployed in the installation site.
- The selected power supply modules meet the system power requirements.
- The position of the indoor emergency power switch is learned before installation. The power switch is cut off in case of accidents.

## 3.2 Precautions

To ensure the normal operation and prolonged service life of the device, please observe the following precautions.

- Do not power on the device during installation.
- Install the device in a well-ventilated position.
- Do not subject the device to high temperatures.
- Keep away from high voltage cables.
- Install the device indoors.
- Do not expose the device in a thunderstorm or strong electric field.
- Keep the device clean and dust-free.
- Cut off the power supply before cleaning the device.
- Do not wipe the device with a damp cloth.
- Do not wash the device with liquid.
- Do not open the enclosure when the device is working.
- Fasten the device tightly.

## 3.3 Mounting the Switch

### 3.3.1 Mounting the Switch on a Wall

---

**Note**

The RG-ES106D-P V2 can be mounted on a wall. (KA3 x 25 mm screws and expansion anchors are delivered with the switch.)

---

The installation steps are as follows:

- (1) Take out two expansion anchors and two screws from the packing materials.
- (2) Drill two holes on the wall. The holes should be level with each other and their centers should be 112.6 mm (4.43 in) apart. Hammer the two expansion anchors into the holes, and drive two screws into the expansion anchors.
- (3) Place the two keyholes on the back of the switch over the two screws mounted on the wall, and pull the switch down slightly to secure it on the screws.

**Figure 3-1 Mounting the Switch on a Wall**

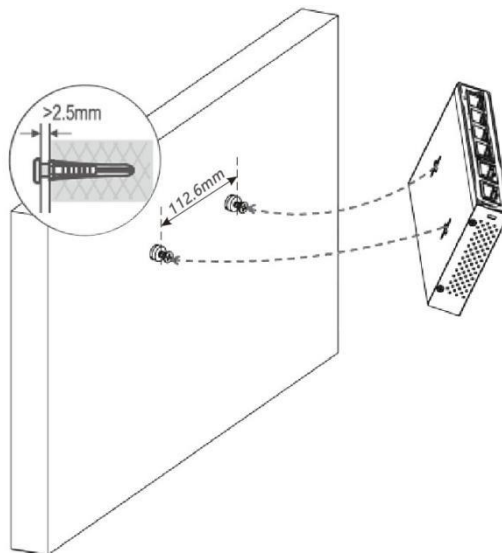

---

**Caution**

Please install the switch on a concrete or non-flammable surface when it is mounted on the wall.

---

### 3.3.2 Mounting the Switch on a Workbench

If you cannot mount the switch on a wall, place it on a clean workbench. The workbench on which the device is mounted and operated must not be moved.

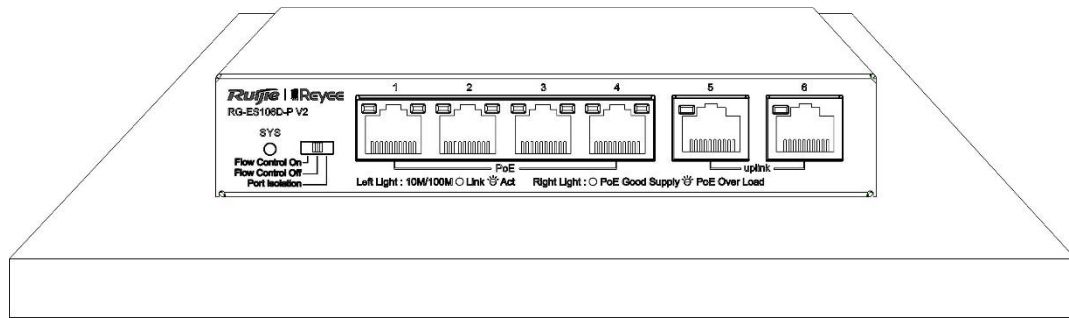
**Figure 3-2 Mounting the Switch on a Workbench**

## 3.4 Grounding the Switch

Connect the grounding cable to the grounding stud on the back panel of the device.

---

### **Note**

The grounding cable is not delivered with the switch and should be purchased separately.

---

### 3.4.1 Connecting Cables

---

#### **Warning**

Please use the power cord delivered with the switch to prevent accidents.

---

After the switch is installed inside the cabinet, connect the switch to the external interfaces with Ethernet cables. The steps are as follows:

- (1) Connect one end of the provided power cord to the system power plug.
- (2) Turn off the main power supply and connect the other end of the power cord to the power socket.
- (3) Use an Ethernet cable with the RJ45 connector to connect the device to the network.

## 3.5 Checking after installation

- Verify that the grounding cable is properly connected.
- Verify that the cables and power cord are properly connected.
- Verify that cables are routed indoors. If not, check whether the power supply and interfaces are protected from lightning strikes.
- Verify that a minimum clearance of 100 mm (3.94 in.) is maintained around the device for air circulation.

# 4 Verifying Operating Status

## 4.1 Powering on the Switch

### 4.1.1 Checklist before Power-on

- Check if the switch is fully grounded.
- Check if the power cord is properly connected.
- Check if the power supply voltage meets the requirement.
- Check whether the Ethernet cable is properly connected, whether the client (may be PC) is started up, and whether configuration parameters are configured.

### 4.1.2 Checklist after Power-on

- Check if the cable connection is correct.
- Check the LED status.

# 5 Appendix

## 5.1 Connectors and Media

- **1000BASE-T/100BASE-TX/10BASE-T Ports**

The 1000BASE-T/100BASE-TX/10BASE-T is a 10/100/1000 Mbps self-adaptive Ethernet port that supports auto MDI/MDIX Crossover.

Compliant with IEEE 802.3ab, 1000BASE-T requires Category 5 100-ohm UTP or Category 5e UTP/STP (STP is recommended) with a maximum distance of 100 meters (328 ft).

The 1000BASE-T port uses four pairs of wires for data transmission, as shown in Figure 5-1.

**Figure 5-1 1000BASE-T Connection**

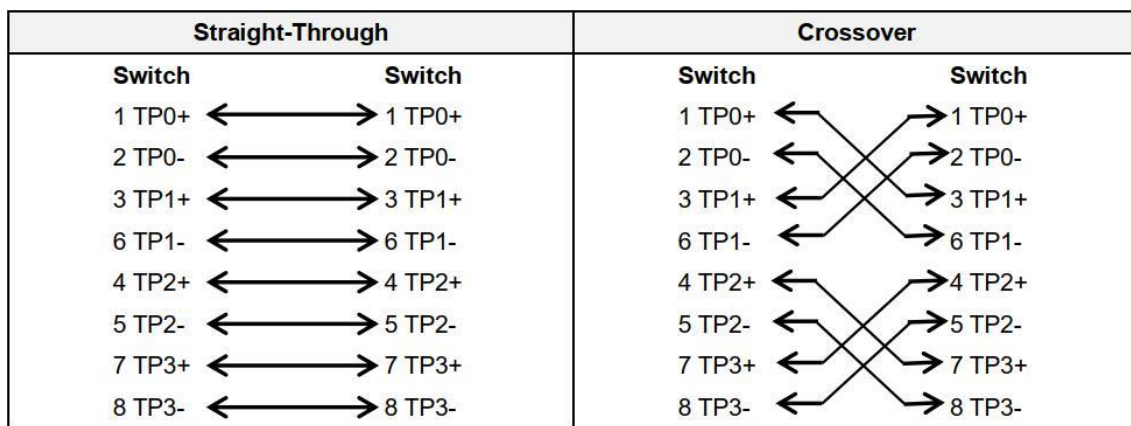

In addition to the above cables, 10BASE-T uses Category 3, 4, 5 100-ohm UTP/STP and 100BASE-T uses Category 5 100-ohm UTP/STP for connections. Both support a maximum length of 100 meters (328 ft). Figure 5-2 shows 100BASE-TX/10BASE-T pin assignments.

**Figure 5-2 100BASE-TX/10BASE-T Pin Assignments**

Pin	Socket	Plug
1	Input Receive Data+	Output Transmit Data+
2	Input Receive Data-	Output Transmit Data-
3	Output Transmit Data+	Input Receive Data+
6	Output Transmit Data-	Input Receive Data-
4,5,7,8	Not used	Not used

Figure 5-3 shows wiring of straight-through and crossover cables for 100BASE-TX/10BASE-T.

Figure 5-3 100BASE-TX/10BASE-T Connection

Straight-Through		Crossover	
Switch	Adapter	Switch	Switch
1 IRD+	1 OTD+	1 IRD+	1 IRD+
2 IRD-	2 OTD-	2 IRD-	2 IRD-
3 OTD+	3 IRD+	3 OTD+	3 OTD+
6 OTD-	6 IRD-	6 OTD-	6 OTD-

## 5.2 Lightning Protection

### 5.2.1 Installing AC Power Arrester (lightning protection cable row)

The AC power port must be connected to an external lightning protection power strip to prevent the switch from being struck by lightning when the AC power cord is introduced from the outdoor and directly connected to the power port of the switch. The lightning protection power strip can be fixed on the cabinet, workbench, or wall in the equipment room by using cable ties and screws. AC power enters the lightning protection power strip and then gets to the switch.

Figure 5-4 Power Arrester

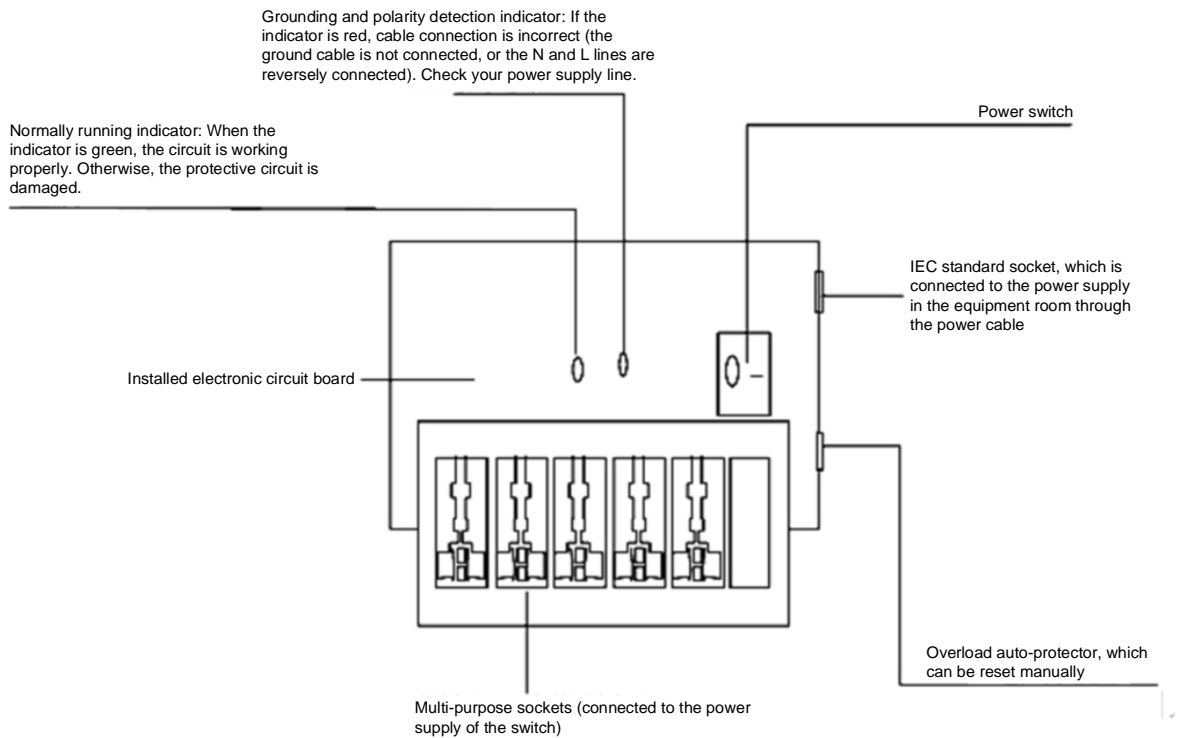

**⚠ Caution**

The power arrester is not delivered with the switch. Please purchase it based on actual requirements.

Precautions for installation:

- Make sure that the PE terminal of the power arrester has been well-grounded;
- After the switch AC power plug is connected to the socket of the power arrester (lightning protection cable row), lightning protection function implements if the RUN LED is Green and the ALARM LED is OFF.
- If the ALARM LED on the power arrester is Red, check whether it is caused by poor grounding connection or by the reversed connection of the Null and Live lines: Use a multimeter to measure the polarity of the power socket for the arrester when the LED is Red, if the N line is on the left and the L line is on the right (facing the socket), the arrester PE terminal is not grounded; if the L line is on the left and the N line is on the right, the polarity of the arrester power cord should be reversed. In this case, open the power arrester and rectify the polarity of the connection. If the LED is still Red, the arrester PE terminal has not been grounded.

## 5.2.2 Installing the Ethernet Port Arrester

Please connect an Ethernet port arrester to the switch to prevent the damage by lightning before connecting an outdoor network cable to the switch.

Tools: Phillips screwdrivers or flat-head screwdriver, multimeter, and diagonal pliers

Installation Steps:

- (1) Tear one side of the protective paper for the double-sided adhesive tape and paste the tape to the housing of the Ethernet port arrester. Tear the other side of the protective paper for the double-sided adhesive tape and paste the Ethernet port arrester to the switch housing. The paste position for the Ethernet port arrester should be as close to the ground terminal of the switch as possible.
- (2) Based on the distance between the switch grounding stud and the Ethernet port arrester, cut the grounding cable for the Ethernet port arrester and firmly tighten the grounding cable to the grounding stud of the switch.
- (3) Use a multimeter to check whether the grounding cable for the arrester is in good contact with the grounding stud and the housing of the switch.
- (4) Connect the arrester by using an adapter cable (note that the external Ethernet cable is connected to the IN end, while the adapter cable connected to the switch is connected to the OUT end) and observe whether the LED on the board is normal or not.
- (5) Use a nylon cable tie to bundle the power cords.

**Figure 5-5 Ethernet Port Arrester Installation**

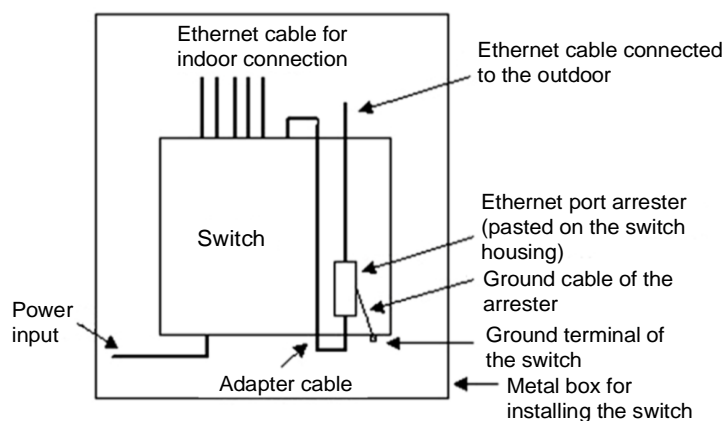

** Caution**

The Ethernet port arrester is only for the 10/100M copper Ethernet ports with the RJ-45 connector;

The Ethernet port arrester is not delivered with the switch. Please purchase it based on actual requirements.

---

During the actual installation, pay attention to the following items:

- Reversed installation direction of the arrester. Connect the external Ethernet cable to the IN end and connect the Ethernet port of the switch to the OUT end.
- Poor grounding of the arrester. The grounding cable of the arrester should be as short as possible to ensure that it is in good contact with the grounding stud of the switch. Use a multimeter to confirm the contact condition after the grounding.
- Incomplete arrester installation. If there is more than one port connected to the peer device on the switch, arresters need to be installed on all connection ports for the purpose of lightning protection.